

Ceiling Support Installation

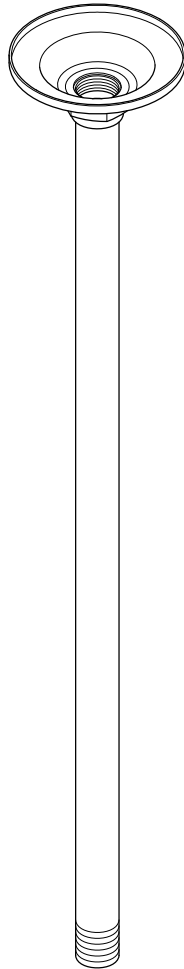

NOTICE

Failure to follow all directions may cause leaks which may result in water damage

www.eodfaucet.com
TOLL-FREE CUSTOMER SERVICE: 877-FAUCET-1(328-2381)
TECHNICAL SUPPORT E-mail: info@eodfaucet.com
12775 Reservoir Street, Chino, CA 91710

TOOLS REQUIRED

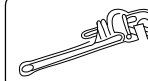

Pipe Wrench



Teflon Tape

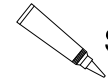

Silicone Sealant

This product is designed to be installed on a level ceiling surface, rough in showerhead stub-out with 1/2" IPS pipe, make sure that the stub-out protrudes 3/4" from the finished ceiling surface.

WARNING:

To avoid wrongful installation to damage thread and product by wrong ceiling pipe thread size, you need to make sure:

- (1) Please MEASURE CEILING pipe is cut 3/4" long distance protrusion from the ceiling, exact size is needed to seal the shower arm correctly.
- (2) To assure your pipe thread is 1/2" IPS with NPT 14 Thread for shower head applications.
- (3) You may test your ceiling PIPE THREAD by mounting a shower head.
- (4) To perform the above require procedure to avoid leak of the installation.

Installation Steps:

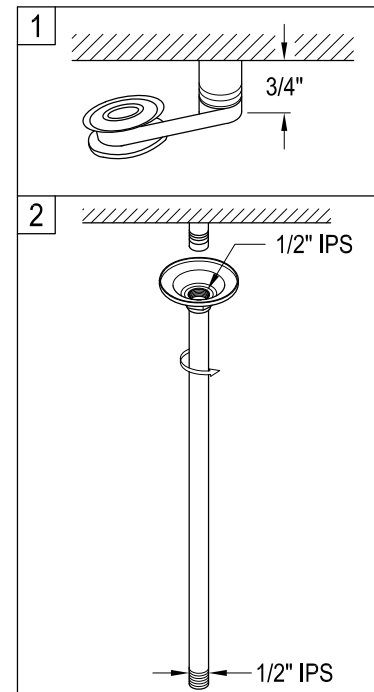

1. Apply a minimum 3 revolutions of Teflon tape to the threads on the stub out.

2. Apply a small bead of silicone based caulking to the perimeter of the flange and thread onto the 1/2" IPS stub-out, clean excess caulking.

Cleaning

Clean with a damp cloth only.
Avoid using metal or abrasive polishes.

INSTALLATION INSTRUCTIONS

Showerhead Sets, Hand Shower Sets and Pull-Out & Pull-Down Sprayer

Before installation:

Hold the existing shower arm up and down to ensure the plumbing behind the wall is rigid to hold the weight of the new shower unit - about 3-4 lbs when filled with water.

Installation manual for shower arm & showerhead:

1

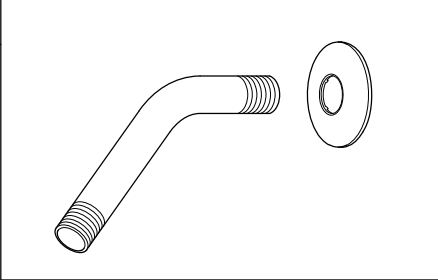

1. Place the flange into the shower rod.

2

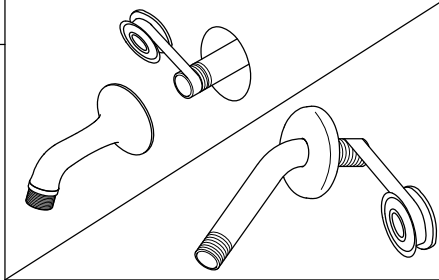

2. Wrap threads on one end of shower rod or the plumbing male nipple with 3 wraps of Teflon tape.

3

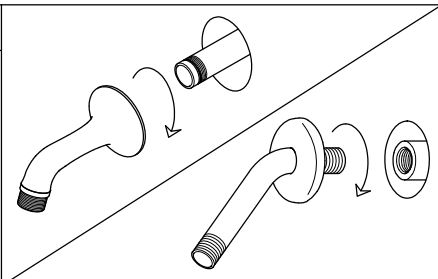

3. Thread the male nipple into female nipple (in wall), tighten with pipe wrench.

4

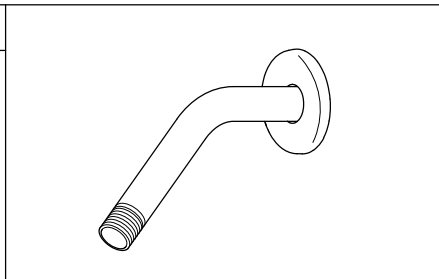

4. Turn the water on and check for leaks, any leaks will require minor tightening or adjustment.

5

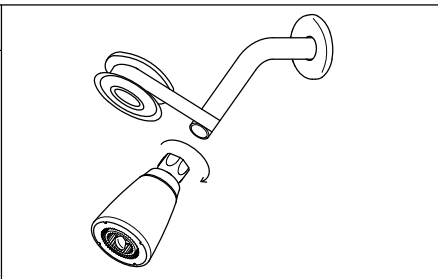

5. Wrap Teflon tape around all the threads on shower rod and hand tighten the showerhead clockwise.

6

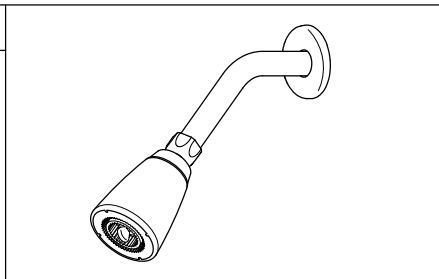

6. Turn the water on and check for leaks, any leaks will require minor tightening or adjustment. If the showerhead leaks at the connection to the thread shower arm, tighten the connection some more by using a wrench.

Need Tools:

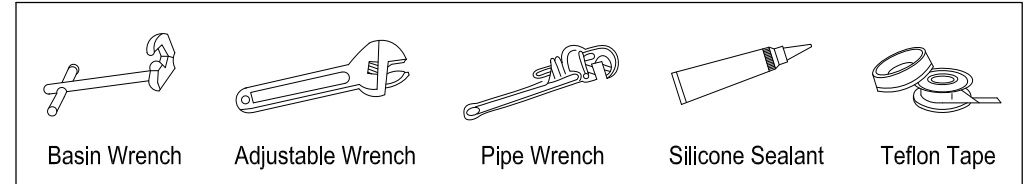

Installation manual for hand shower :

1

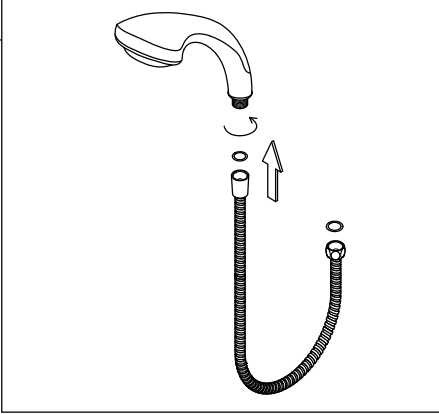

1. Put a washer to the cone shape hose nut and hand tightens the hand shower clockwise.

2

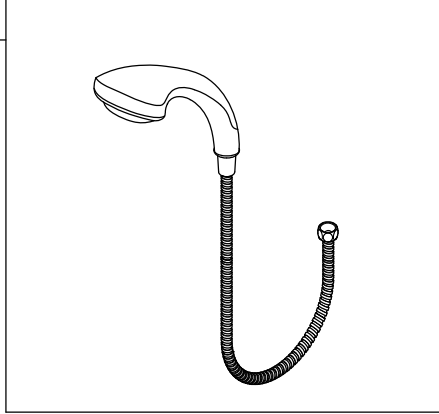

2. Turn on the water and check for leaks, if the hand shower leaks at the connection to the hose, hand tighten the connection some more.

Installation manual for pull-out & pull-down sprayer:

1

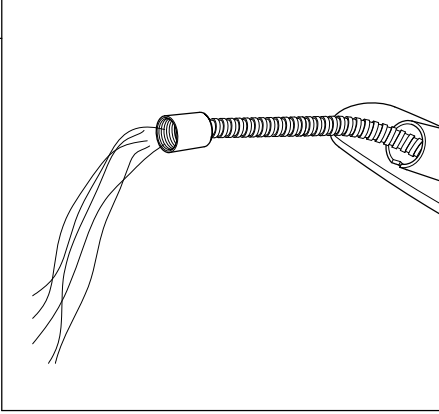

1. Thread hose to spray head and feed from the top into the faucet spout, turn the spout to the right or to the left fully to facilitate the insertion of the hose.

2

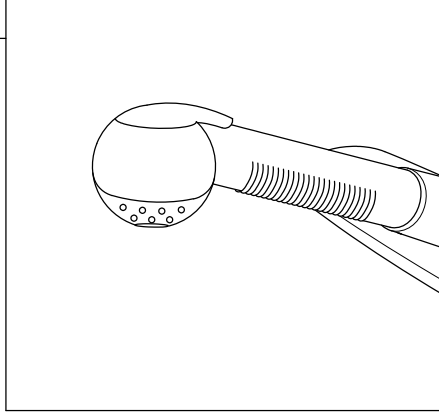

2. After applying Teflon tape thread other end of hose to spray hose outlet, located underneath the faucet. Remove sprayhead and let water run for at least one minute to eject any debris remaining on the line, reinstall sprayhead.